



Self Priming Centrifugal Pump

Model T2A3-B

Size 2" x 2"

VARIOUS PATENTS APPLY

PUMP SPECIFICATIONS

Size: 2" x 2" (51 mm x 51 mm) NPT - Female.

Casing: Gray Iron 30.

Maximum Operating Pressure 79 psi (545 kPa).*

Semi-Open Type, Two Vane Impeller: Ductile Iron 65-45-12.

Handles 1 1/2" (38,1 mm) Diameter Spherical Solids.

Impeller Shaft: Alloy Steel 4150.

Shaft Sleeve: Alloy Steel 4130.

Replaceable Wear Plate: Carbon Steel 1026

Removable Cover Plate: Gray Iron 30; 13.6 lbs. (6 kg).

Seal Plate: Gray Iron 30.

Externally Replaceable Flap Valve: Neoprene TM/Steel Reinforcing.

Bearing Housing: Gray Iron 30.

Radial Bearing: Open Single Row Ball.

Thrust Bearing: Open Double Row Ball.

Bearing and Seal Cavity Lubrication: SAE 30 Non-Detergent Oil.

Flanges: Gray Iron 30.

Gaskets: Buna-N, Vegetable Fiber, Cork and Rubber.

O-Rings: Buna-N.

Internal Wetted Hardware: Standard Plated Steel.

External Hardware: Standard Plated Steel.

Brass Pressure Relief Valve.

Bearing and Seal Cavity Oil Level Sight Gauges.

Optional Equipment: Automatic Air Release Valve.

120V/240V Casing Heater. High Pump Temperature

Shutdown Kit. GR Hard Iron Seal Plate. Hardened

Steel Wear Plate. Permalon Seal. Self-Cleaning Wear Plate.

Gray Iron 30 Suction and Discharge Spool Flanges:

2" ASA (**Specify Model T2A3-B /F**).

50 mm DIN 2527 (PN 16) (**Specify Model T2A3-B /FM**).

**Consult Factory for Applications Exceeding Maximum Pressure and/or Temperature Indicated.*



Shown with Optional Suction & Discharge Spool Flanges (Available in ASA or DIN Standard Sizes).

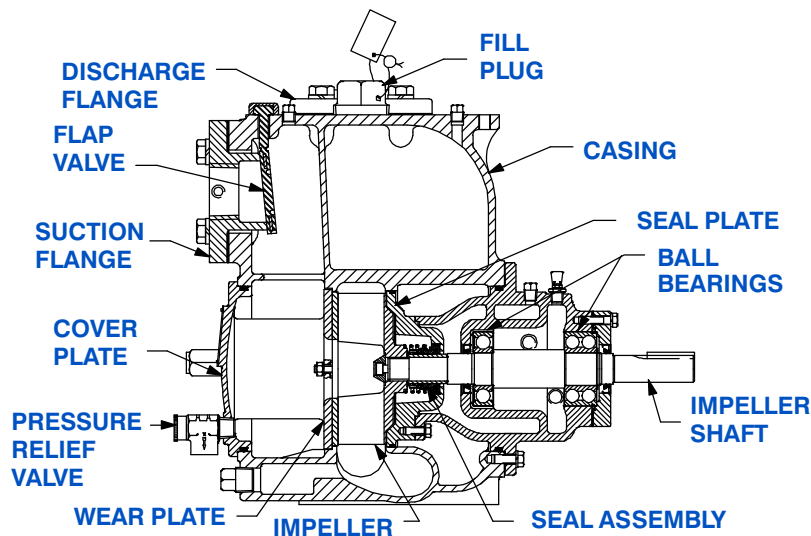
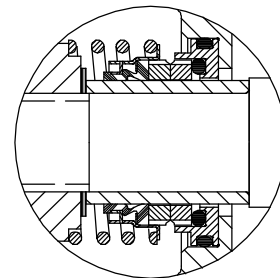

SEAL SPECIFICATIONS

Mechanical, Oil-Lubricated, Double Floating, Self-Aligning. Tungsten Titanium Carbide Rotating and Stationary Faces. Stainless Steel 316 Stationary Seat. Fluorocarbon Elastomers (DuPont Viton[®] or Equivalent). Stainless Steel 18-8 Cage and Spring. Maximum Temperature of Liquid Pumped, 160°F (71°C).*



GORMAN-RUPP PUMPS

www.grpumps.com

Specifications Subject to Change Without Notice

Printed in U.S.A.

Specification Data

SECTION 55, PAGE 980

APPROXIMATE DIMENSIONS and WEIGHTS

NET WEIGHT: 210 LBS. (95 KG.)*
SHIPPING WEIGHT: 220 LBS. (10 KG.)*
EXPORT CRATE: 7.9 CU. FT. (0,22 CU. M.)
***ADD 8 LBS. (3,6 KG.) W/EACH SPOOL FLANGE**

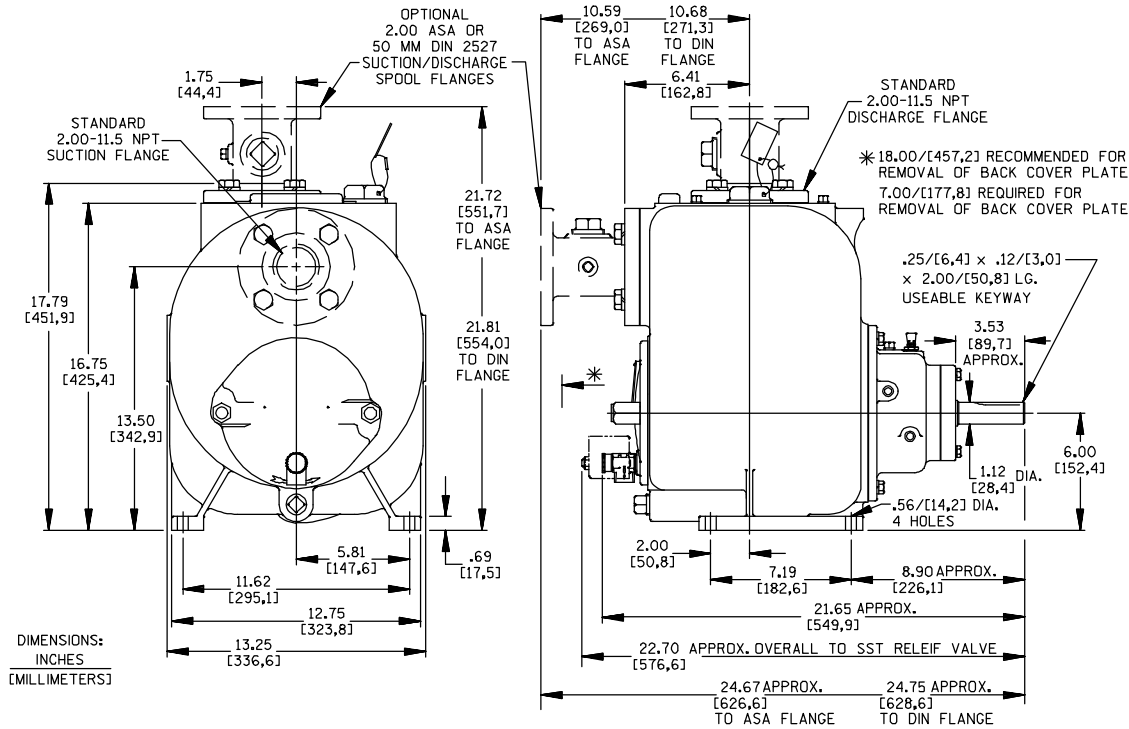

OPTIONAL ASA OR DIN STANDARD SUCTION & DISCHARGE SPOOL FLANGES AVAILABLE

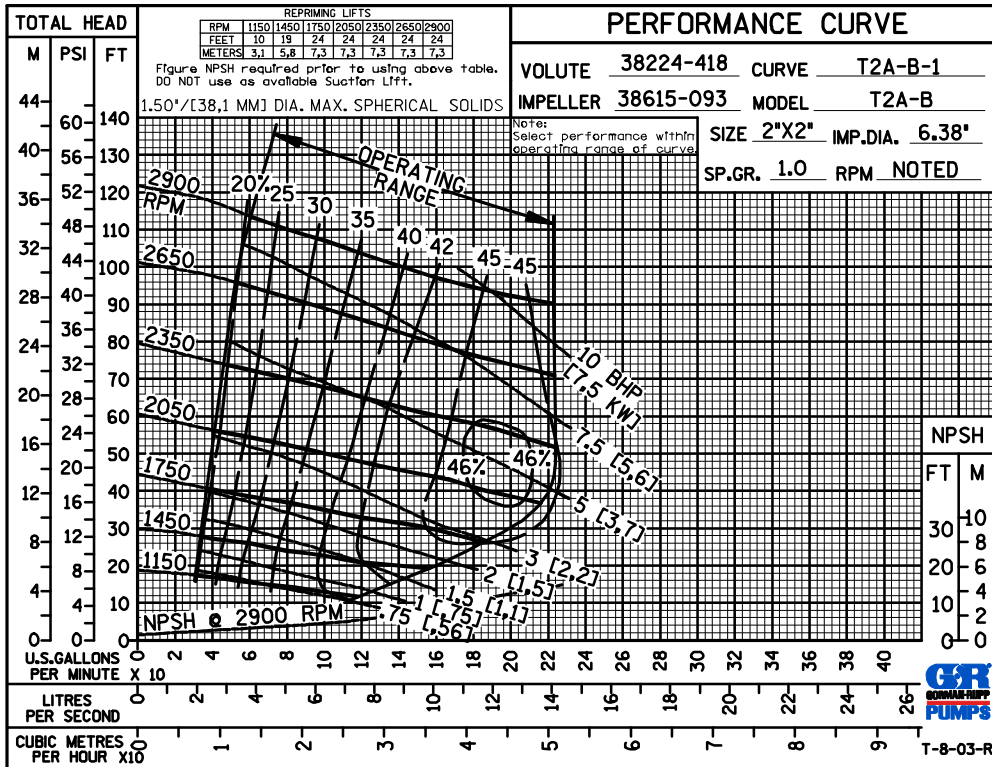

GORMAN-RUPP PUMPS

www.grpumps.com

Specifications Subject to Change Without Notice

Printed in U.S.A.

**MULTI-SPEED
PERFORMANCE
BASED ON
WATER
TRIMMED
IMPELLER**

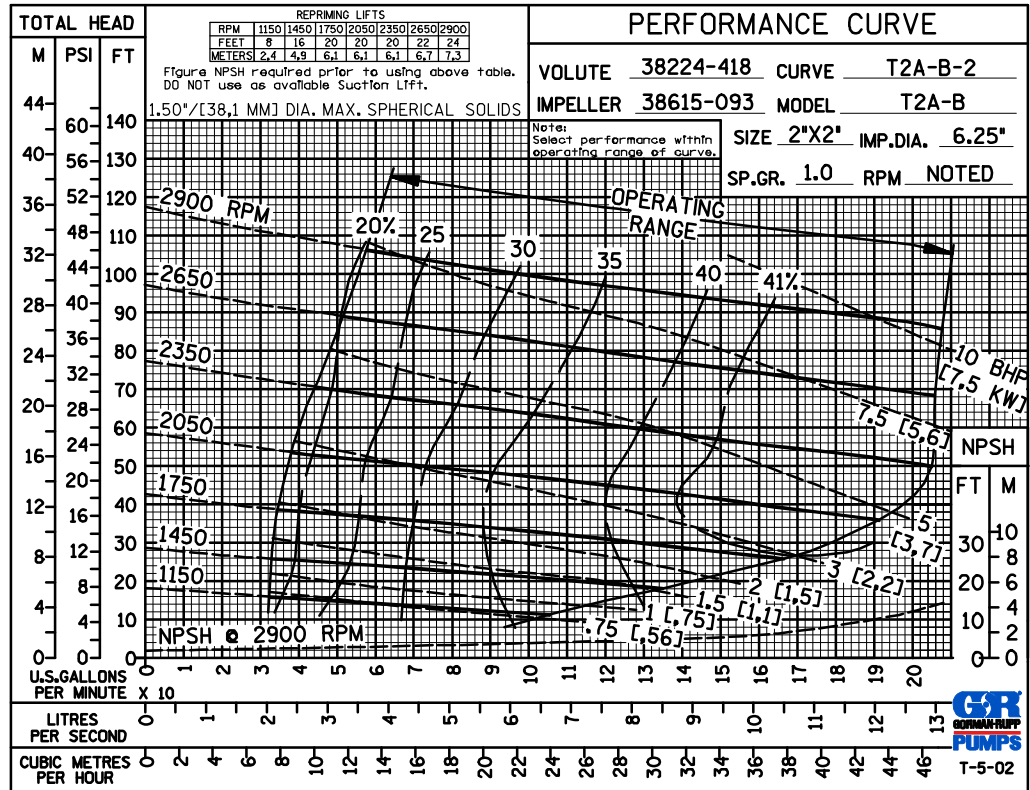

**MULTI-SPEED
PERFORMANCE
BASED ON
WATER
TRIMMED
IMPELLER**

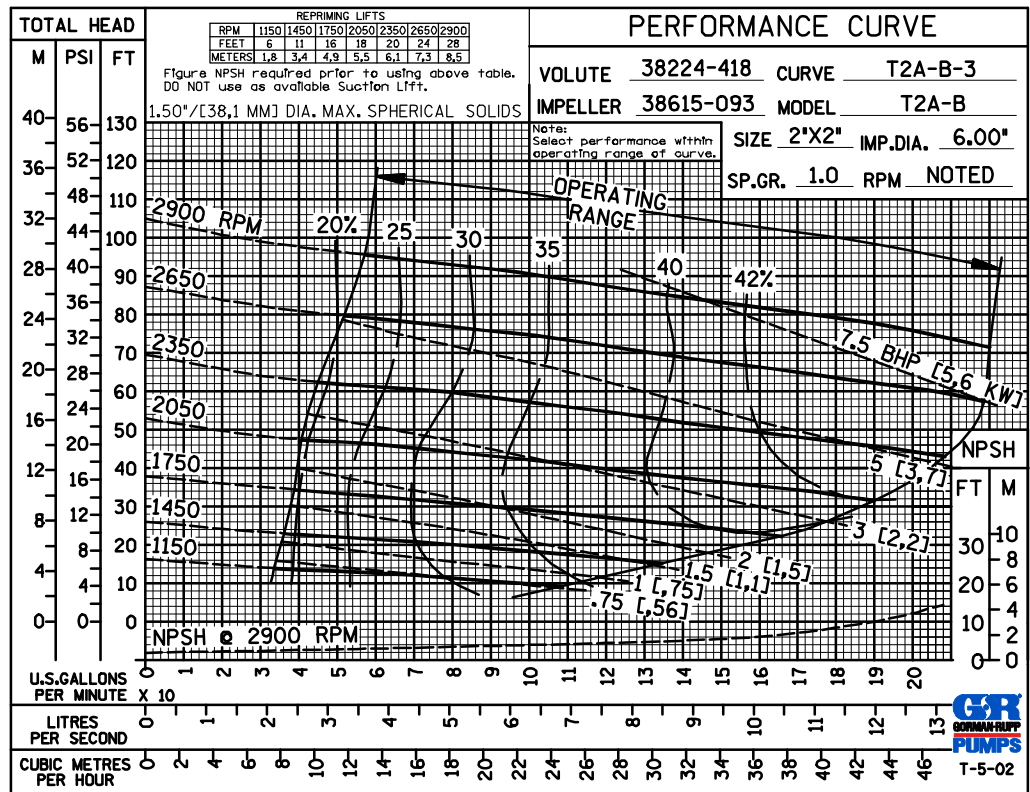

GORMAN-RUPP PUMPS

www.grpumps.com

Specifications Subject to Change Without Notice

Printed in U.S.A.

**MULTI-SPEED
PERFORMANCE
BASED ON
WATER
TRIMMED
IMPELLER**

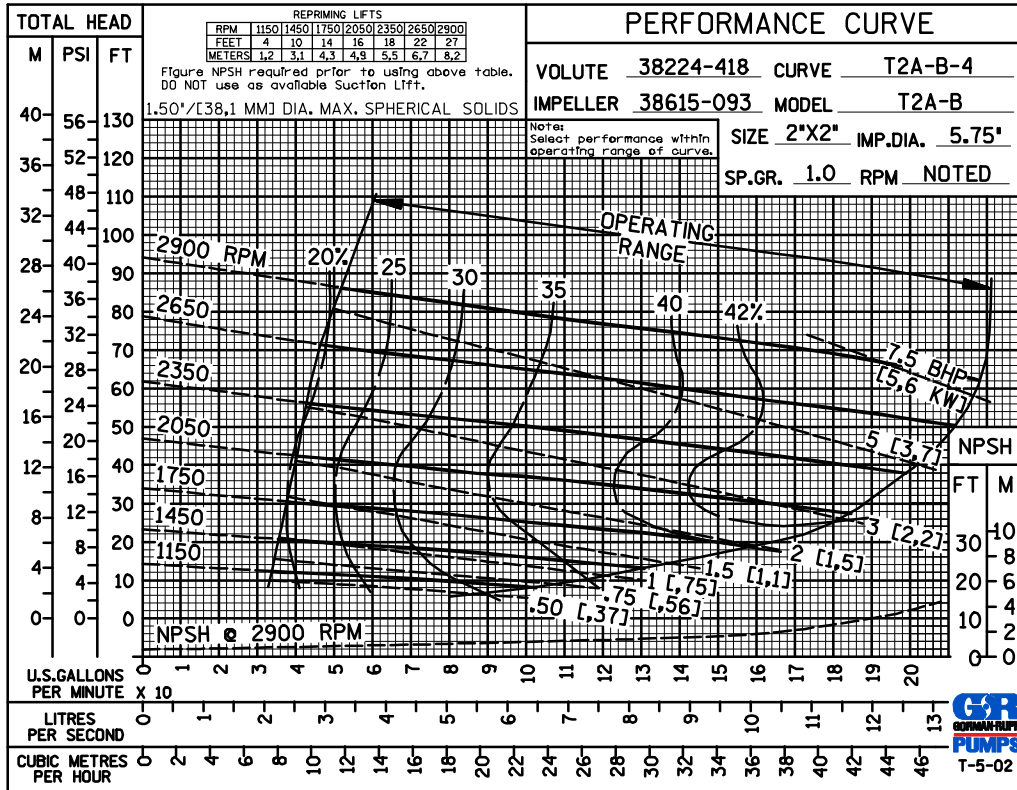

**MULTI-SPEED
PERFORMANCE
BASED ON
WATER
TRIMMED
IMPELLER**

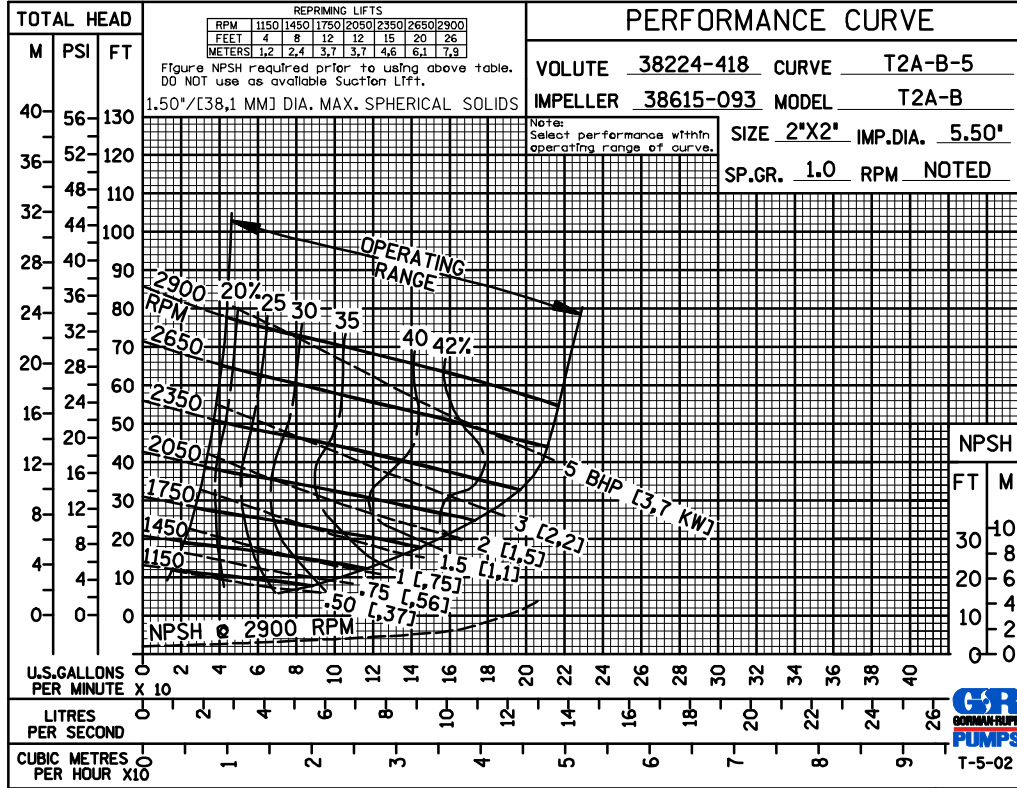

GORMAN-RUPP PUMPS

www.grpumps.com

Specifications Subject to Change Without Notice

Printed in U.S.A.

PERFORMANCE
BASED ON
WATER
TRIMMED
IMPELLER

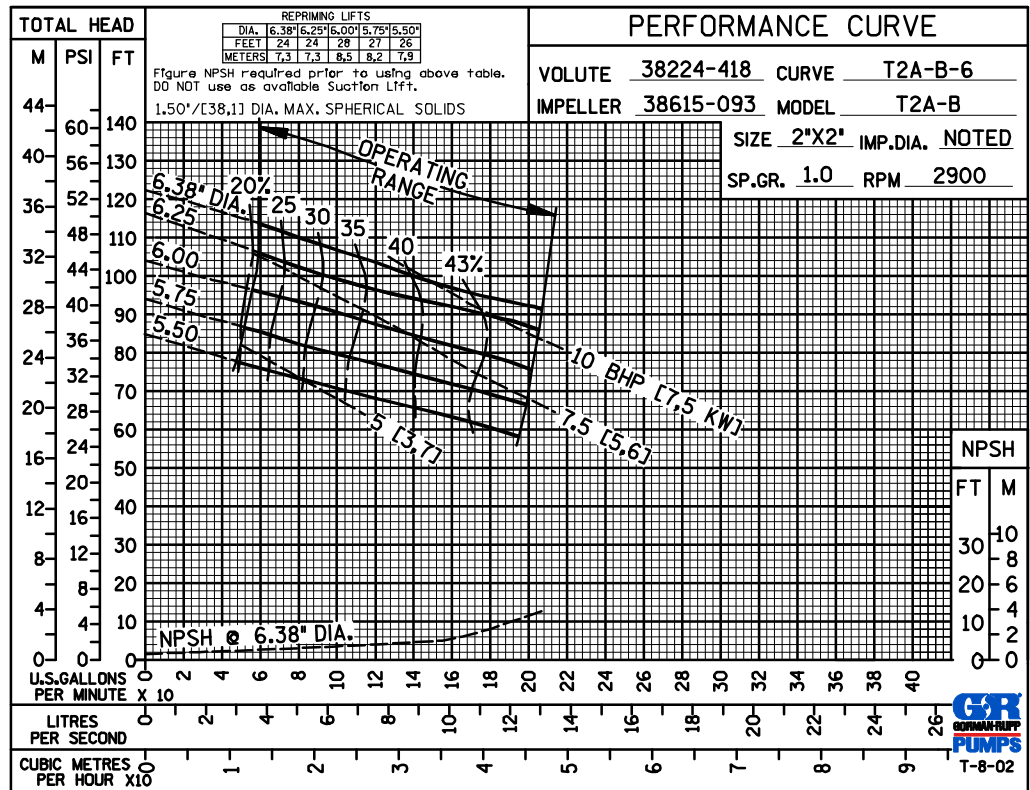

PERFORMANCE
BASED ON
WATER
TRIMMED
IMPELLER

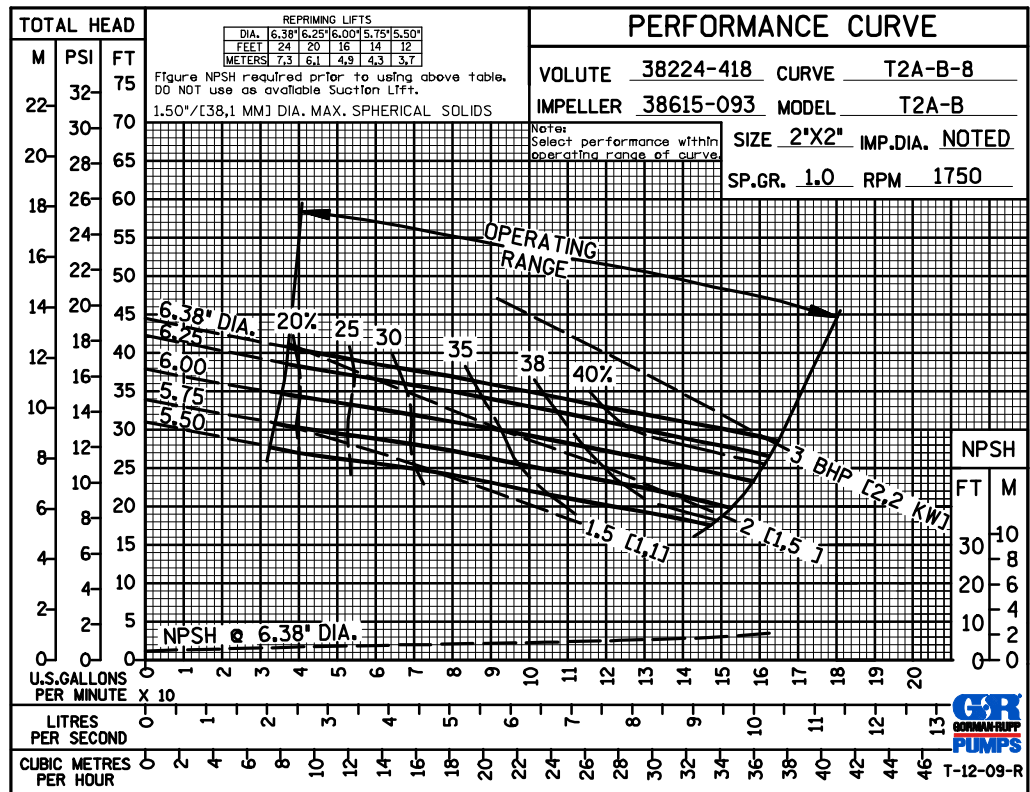

GORMAN-RUPP PUMPS

www.grpumps.com

Specifications Subject to Change Without Notice

Printed in U.S.A.

PERFORMANCE
BASED ON
WATER
TRIMMED
IMPELLER

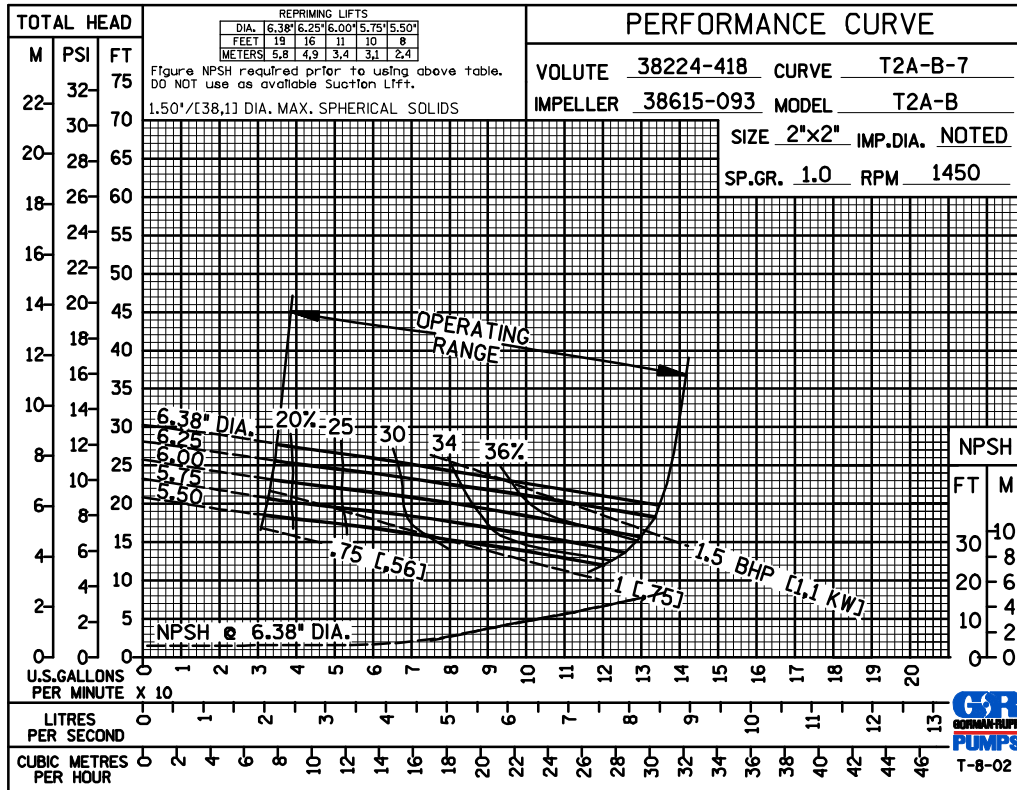

PERFORMANCE
BASED ON
WATER
TRIMMED
IMPELLER

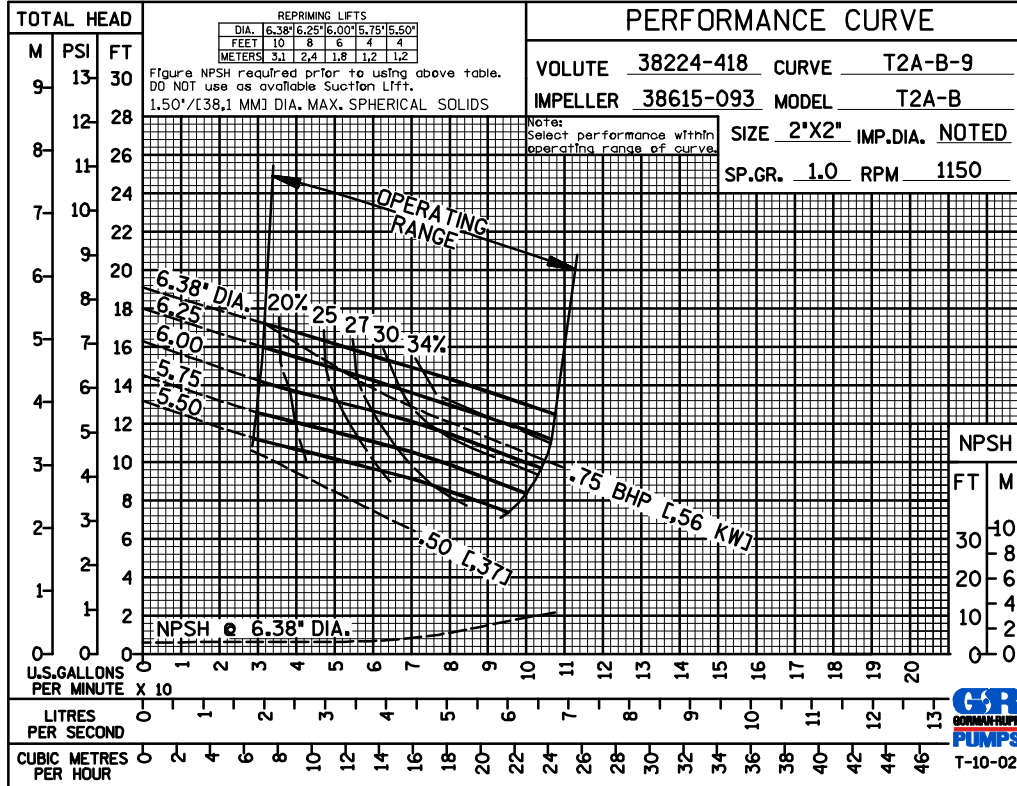

GORMAN-RUPP PUMPS

www.grpumps.com

Specifications Subject to Change Without Notice

Printed in U.S.A.

PERFORMANCE
BASED ON
WATER
PUMPS IN
PARALLEL

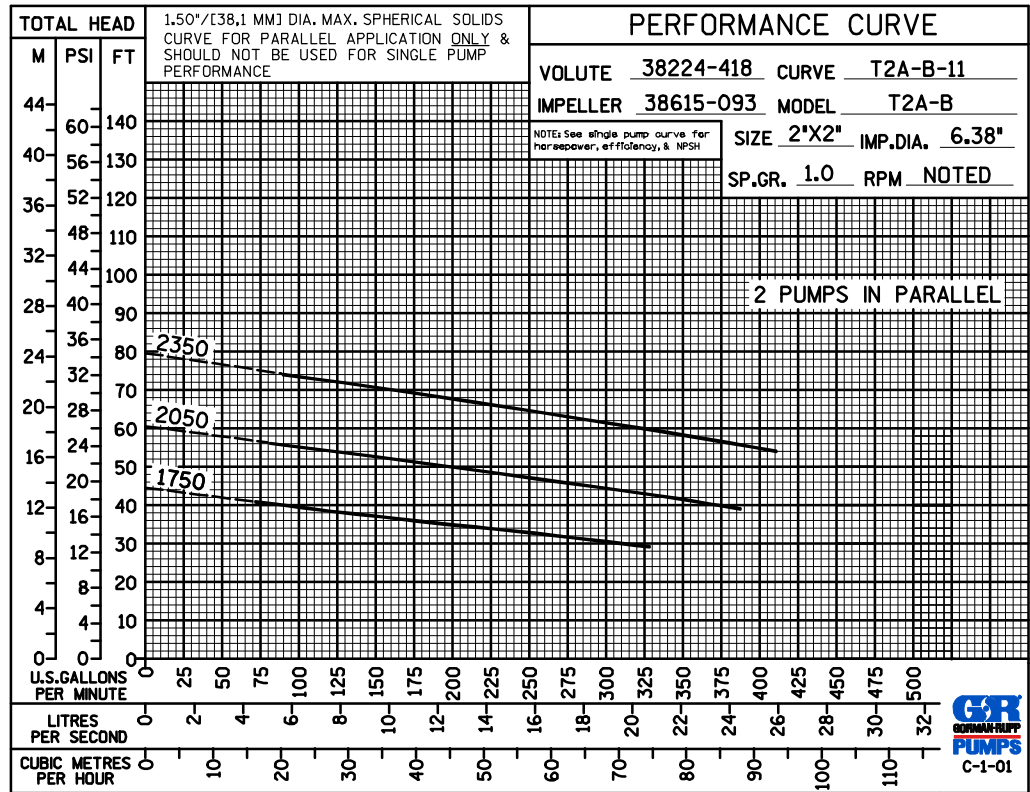

PERFORMANCE
BASED ON
WATER
PUMPS IN
SERIES

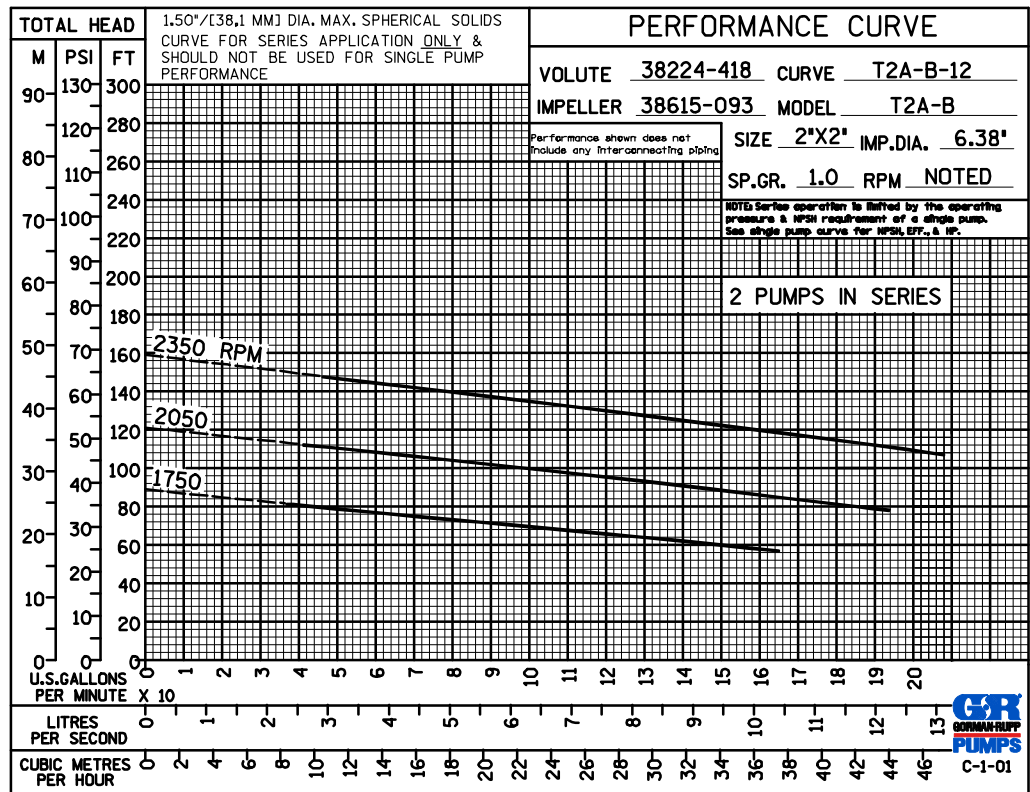

GORMAN-RUPP PUMPS

www.grpumps.com

Specifications Subject to Change Without Notice

Printed in U.S.A.